

## Aluminum Profiles

Alumium storefront Windows Doors solution

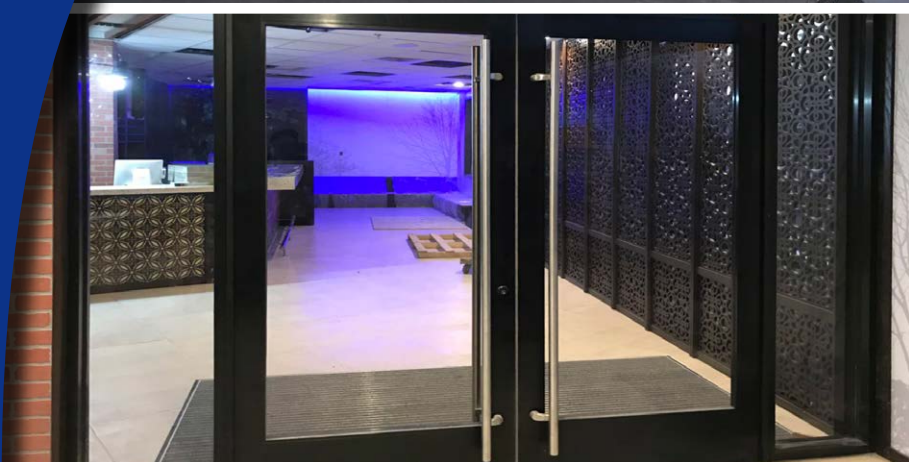

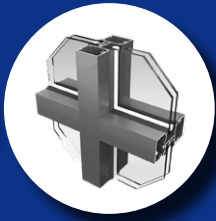
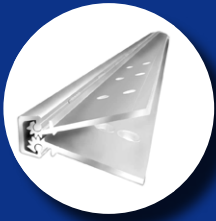

## Company Profile

J&M Window Door is a privately owned windows and doors manufacturer, located on Roosevelt Boulevard in Philadelphia. We manufacture storefronts, folding doors, rolling gates, shower doors, aluminum railings, as well as stock an array of steel pipes, tubes, angles, channels, panels, aluminum profiles and door hardware. Our products can be utilized across a multitude of applications, ranging from commercial properties such as hotels, apartments, stores to residential properties.

Our mission is to provide innovative and high-performance products to fulfill all commercial and residential needs. We are committed to producing competitively priced high-quality products in a timely matter whilst ensuring that we are meeting and exceeding our customer's expectations.

J&M Window Door was initially a construction company, so our knowledge and expertise in the field established a high standard by which all our products are measured by. With our advanced technology along with digital display CNC machine, Cutter milling machine & Crimping machine, we are well equipped with a full range of capabilities to produce premium products. We are continuously upgrading and refining our processes to provide our customers further effectively with exceptional service and products. We hope to not just be your supplier, but rather your longtime partner.

Thank you for choosing J&M Window Door.





## Table Of Contents

Aluminium stock door	02
Narrow stile door	
Medium stile door	
Aluminium Custom-made door	
D Series Door Profiles	06
Door Extrusions	07
Door Assembly	08
Herculite door	09
Bi-fold sliding door	10
Frameless sliding door	11
Frameless sliding door system	12
JM-50 Series Center Glaze Systems	13
JM-51 Series Center Glaze Systems	14
Screw Spline Assembly	15
Shear Block Assembly	16
Fin, Flat Tube, Angle & Channel	17
Architectural panel & Stock door glass	18
Door Hardware	19
Handle	22
Screw	23
Shower Door Enclosure	24
Glass	25
Storefront Prepare Service	26

## Aluminum Stock Door

Standard D200 Narrow Stile Door

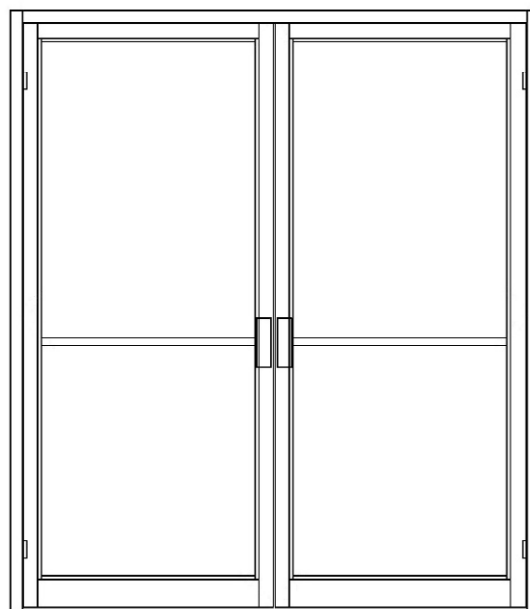
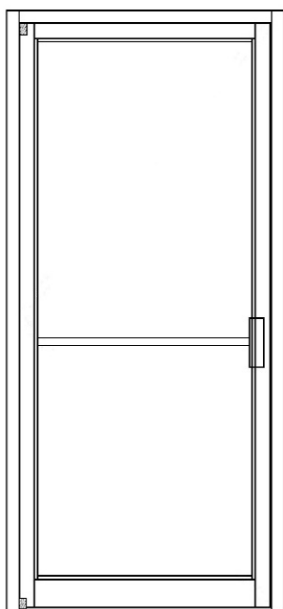

Finish: Clear anodized / Extra dark bronze anodized

Glazing: 1/4" or 1" Glazing

Hinge: Offset Pivot / Butt Hinge / Continuous Hinge

Top rail & vertical stile: 2 1/8"

Bottom rail: 4"

Handle: Standard push and pull handle

Door framed with JM-Series Center Glaze System:

JM-40 (1 3/4" X 4") Non-thermal

JM-50 (1 3/4" X 4 1/2") Non-thermal

JM-51 (2" X 4 1/2") Non-thermal

Lock: Standard MS lock with cylinders both sides

Flush bolts on inactive door, lock on active door

Narrow Stile Door				
Product	Part No.	Description	Hinge	Color
Single door	NDS3684P	36x84	Pivot	Silver
	NDB3684P	36x84	Pivot	Black
	NDS3684B	36x84	Butt	Silver
	NDB3684b	36x84	Butt	Black
	NDS4284B	42x84	Butt	Silver
	NDB4284B	42x84	Butt	Black
Double door	NDS7284P	72x84	Pivot	Silver
	NDB7284P	72x84	Pivot	Black
	NDS7284B	72x84	Butt	Silver
	NDB7284B	72x84	Butt	Black

## Aluminum Stock Door

Standard D350 Medium Stile Door

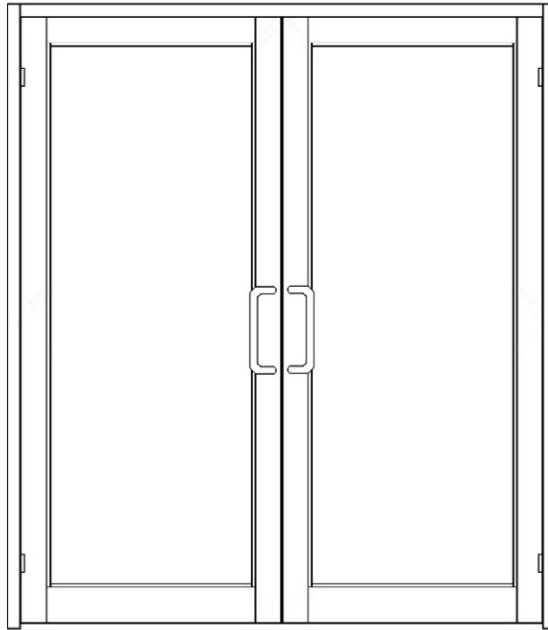
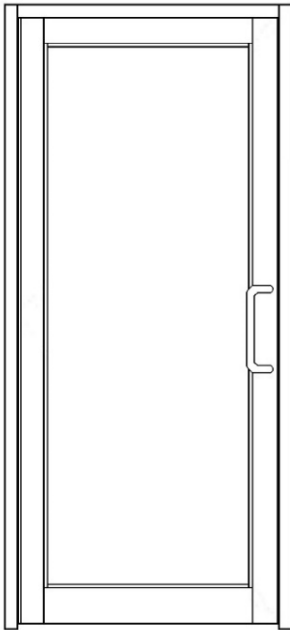

Finish: Clear anodized / Extra dark bronze anodized

Glazing: 1/4" or 1" Glazing

Hinge: Butt Hinge / Continuous Hinge

Top rail & vertical stile: 3 1/2"

Bottom rail: 5"

Handle: Standard 12" round handle

Door framed with JM-Series Center Glaze System:

JM-40 (1 3/4" X 4") Non-thermal

JM-50 (1 3/4" X 4 1/2") Non-thermal

JM-51 (2" X 4 1/2") Non-thermal

Lock: Standard MS lock with cylinders both sides

Flush bolts on inactive door, lock on active door

Medium Stile Door				
Product	Part No.	Description	Hinge	Color
Single door	MDS3684B	36x84	Butt	Silver
	MDB3684B	36x84	Butt	Black
	MDS3696B	36x96	Butt	Silver
	MDB3696B	36x96	Butt	Black
	MDS4284B	42x84	Butt	Silver
	MDB4284B	42x84	Butt	Black
Double door	MDS7284B	72x84	Butt	Silver
	MDB7284B	72x84	Butt	Black
	MDS7296B	72x96	Butt	Silver
	MDB7296B	72x96	Butt	Black

## Aluminum Custom-made door

Custom-made D500 Wide Stile Door

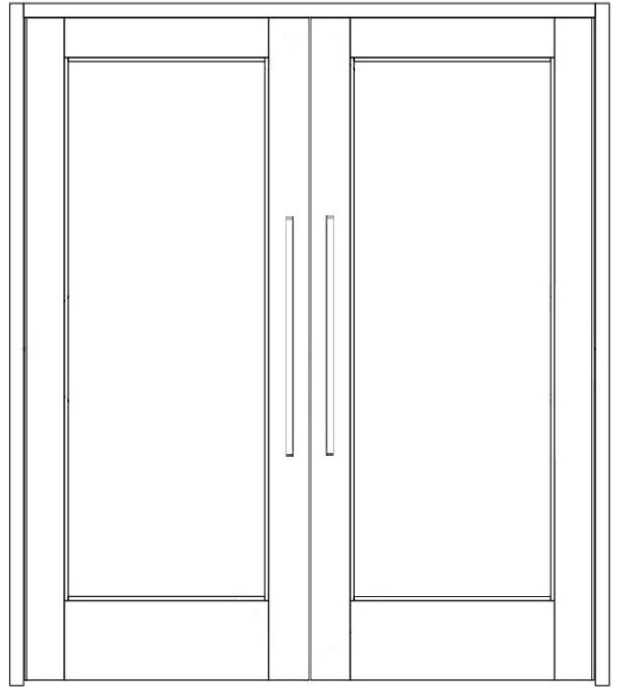
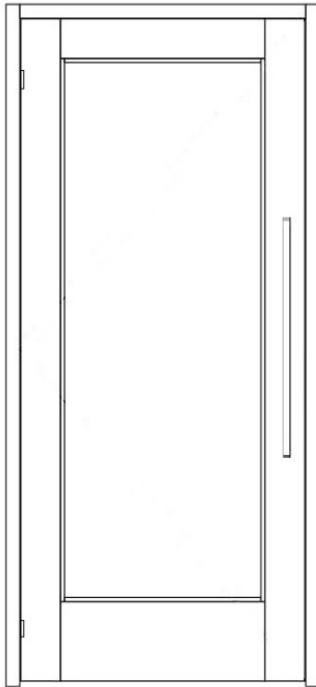

### Custom-made size

Finish: Clear anodized / Extra dark bronze anodized

Glazing: 1/4" or 1" Glazing

Hinge: Butt Hinge / Continuous Hinge

Top rail & vertical stile: 5"

Bottom rail: 7 3/4" or 10"

Handle: Standard 12" round handle / Ladder pull handle

Door framed with JM-Series Center Glaze System:

JM-40 (1 3/4" X 4") Non-thermal

JM-50 (1 3/4" X 4 1/2") Non-thermal

JM-51 (2" X 4 1/2") Non-thermal

Lock: Standard MS lock with cylinders both sides

Flush bolts on inactive door, lock on active door



## D Series Door Profiles

### Typical Profile Combination

Type	Single Door	Pair Door	Top Rail	Bottom Rail
Narrow Stile				
Medium Stile				
Wide Stile				

### Other Optional Top/Bottom & Glazing Options



















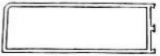
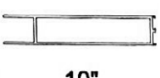
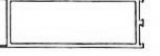

Top/Bottom Rails	Mid Rails	1/4" Glass Moulding	1" Glass Moulding

### Typical Frame Combination

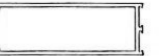
Type	Header	Jamb	Door Stop	Saddle
JM-50				
JM-51				
JM-40				

## Door Extrusions

Commercial Narrow, Medium, & Wide Stiles Door Extrusions

JM4011	2 1/8" VERTICAL STILE		JM4021	2 1/8" TOP RAIL	
JM4012	2" VERTICAL STILE (LOCK)		JM4022	3 1/2" TOP RAIL	
JM4013	2 1/8" VERTICAL STILE (FLUSH-BOLT)		JM4023	3 1/2" BOTTOM RAIL (OPTIONAL)	
JM4014	3 1/2" VERTICAL STILE		JM4024	4" BOTTOM RAIL	 4"
JM4015	3 1/2" VERTICAL STILE (LOCK)		JM4025	5" BOTTOM RAIL	 5"
JM4016	3 1/2" VERTICAL STILE (FLUSH-BOLT)		JM4026	7 1/2" BOTTOM RAIL	 7 1/2"
JM4017	5" VERTICAL STILE		JM4027	10" BOTTOM RAIL	 10"
JM4018	5" VERTICAL STILE (LOCK)		JM4028	1 1/2" MIDDLE RAIL	
JM4019	5" VERTICAL STILE (FLUSH-BOLT)		JM4032	1" GLAZING BEAD (3/4" HING)	
JM4031	1/4" GLAZING BEAD (1/2" HIGH)		JM4033	WEATHER STRIP CAP	
JM4036	1/4" ADAPTOR		JM4034	UNIVERSAL CLIP	
			JM4035	INTERMEDIATE RAIL (9/16")	



## Door Assembly

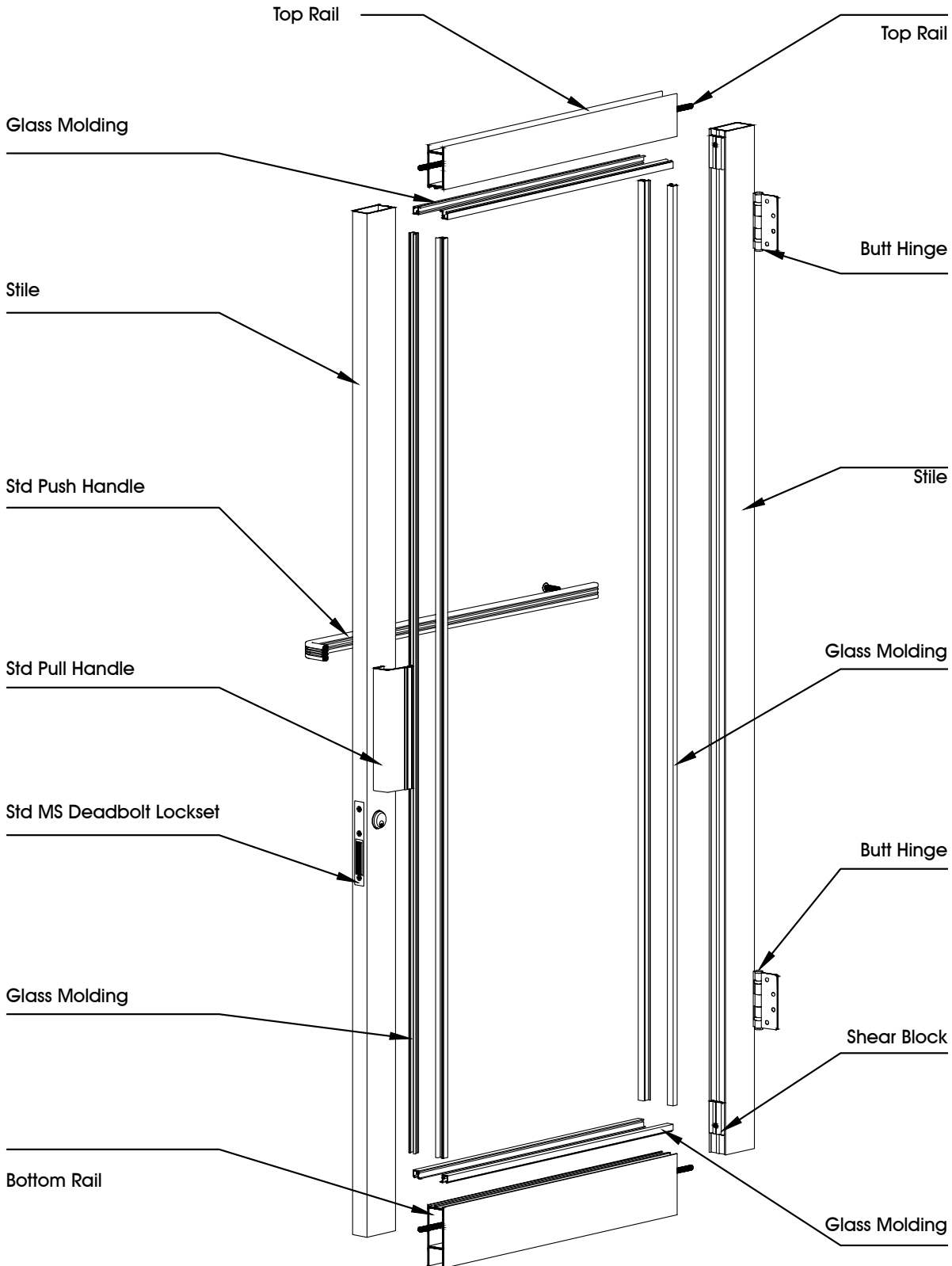

## Herculite Door

Finish: Clear anodized / Extra dark bronze anodized

Glazing: 1/2" Clear tempered glass with polished edges

Top rail & bottom rail: 3 3/8"

Hinge: Top & bottom center pivot

Handle: 24" Stainless steel H-pull Handle

Lock: Bottom deadbolt lock

Key cylinder on both sides

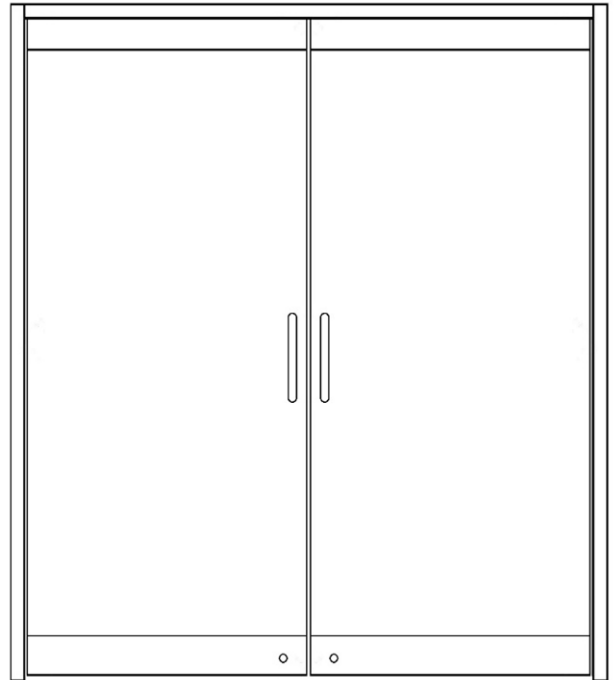
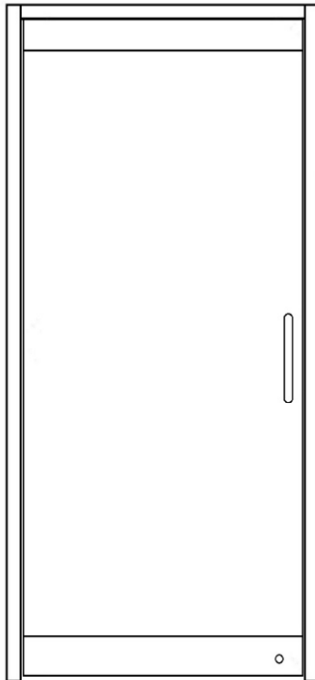

## Bi-fold sliding door



Finish: Clear anodized / Extra dark bronze anodized

Glazing: 1/4" or 1" Glazing

Top rail, bottom rail & vertical stile: 3"

Frame: 2 1/4" x 2 1/4" Profile non-thermal head track & jamb

Sill: Standard outswing flush sill

Handle & lock: European handle lockset assembly

Detail: Corners are mitered, anchors reinforced, hydraulically crimped, and back sealed with small-joint seam sealer



## Frameless sliding door system

FLS401 wall mounted single slider

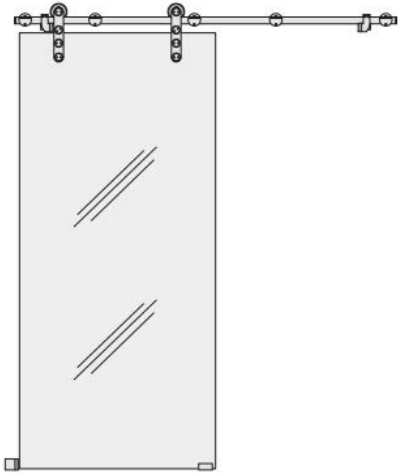

FLS402 wall mounted bi-parting sliders

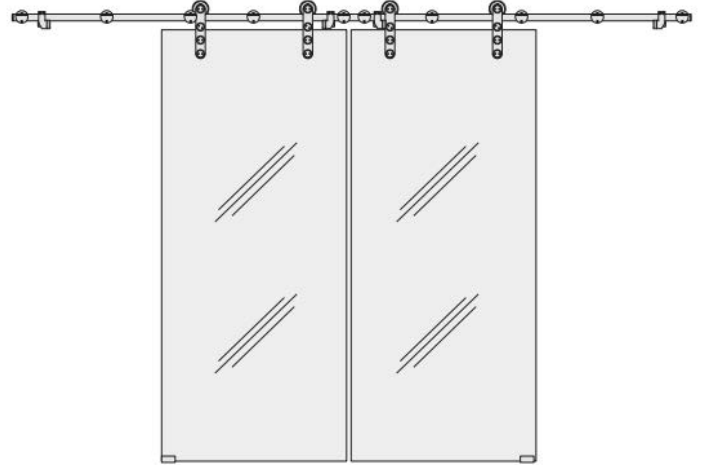

FLS403 glass mounted single slider

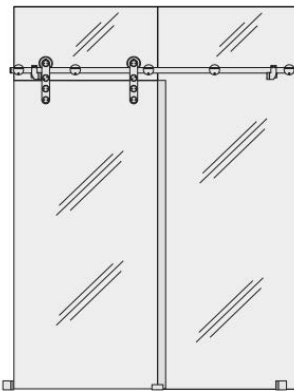

FLS404 glass mounted single slider with sidelite

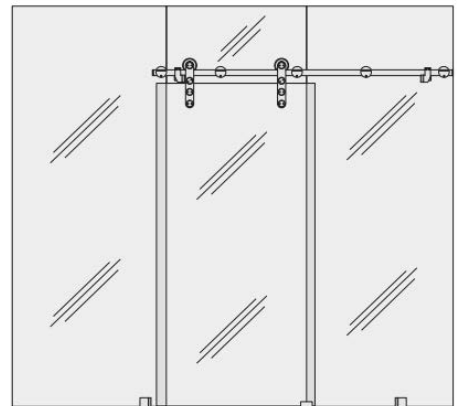

**Options:**

- Finish: Chrome / Brushed nickel
- Glass: Clear / Bronze / Acid etch
- Glass thickness: 3/8" or 1/2" tempered glass
- Handle: 24" / 36" / 48" Stainless steel H-pull handle
- Lock: American style patch lock

**Door system limitations:**

- Maximum Door Weight: 220 Lbs.
- Minimum Door Width: 37-7/8"
- Maximum Door Width: 53-1/2"
- Maximum Door Height: 98-1/2"
- Maximum Track Length: 104"







## Frameless sliding door system



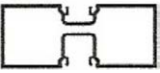
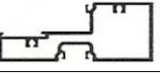
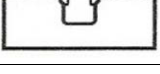
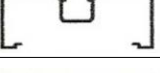
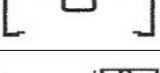
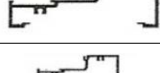
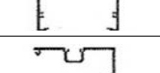
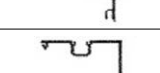
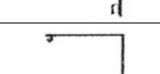
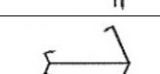
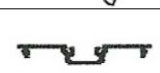
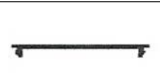

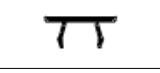







## JM-50 Series Center Glaze Systems

1 3/4" x 4 1/2" Storefront Materials For 1" Glass

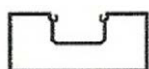
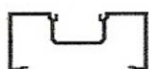
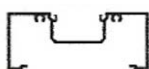
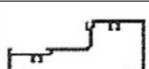
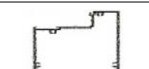
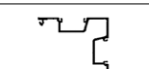
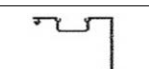
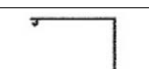
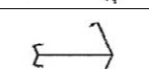
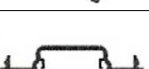
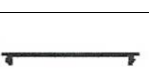
Part No.	Sectional View	Description	Length	Color
JM5011		Double Pocket, Closed Back W/ Screw Spline	24 ft	Silver/Black
JM5010		Sill Closed Back W/ Screw Spline	24 ft	Silver/Black
JM5009		Single Pocket, Closed Back	24 ft	Silver/Black
JM5008		Single Pocket, Open Back W/O Screw Spline	24 ft	Silver/Black
JM5007		Single Pocket, Open Back W/ Screw Spline	24 ft	Silver/Black
JM5006		Sill, Opened Back W/ Screw Spline	24 ft	Silver/Black
JM5005		4 1/2" High Sill	24 ft	Silver/Black
JM5004		Half Corner W/ 2 Pockets	24 ft	Silver/Black
JM5003		Half Corner W/ 1 Pocket	24 ft	Silver/Black
JM5002		Half Corner W/O Pocket	24 ft	Silver/Black
JM5001		135° Corner Mullion	24 ft	Silver/Black
JM5022		Open Back Filler W/ Pocket	24 ft	Silver/Black
JM5021		Open Back Flat filler W/O Pocket	24 ft	Silver/Black
JM5020		Sill Cap	24 ft	Silver/Black
JM5019		Snap-in Door Stop	24 ft	Silver/Black
JM5018		Pocket Filler	24 ft	Silver/Black
JM5017		Sill Shear Block	15 ft	Silver/Black
JM5016		Head Shear Block	15 ft	Silver/Black

## JM-51 Series Center Glaze Systems

2"x4 1/2" Storefront Materials For 1" Glass

Part No.	Sectional View	Description	Length	Color
JM5011		Double Pocket, Closed Back W/ Screw Spline	24 ft	Silver/Black
JM5010		Sill Closed Back W/ Screw Spline	24 ft	Silver/Black
JM5009		Single Pocket, Closed Back	24 ft	Silver/Black
JM5008		Single Pocket, Open Back W/O Screw Spline	24 ft	Silver/Black
JM5007		Single Pocket, Open Back W/ Screw Spline	24 ft	Silver/Black
JM5006		Sill, Opened Back W/ Screw Spline	24 ft	Silver/Black
JM5005		4 1/2" High Sill	24 ft	Silver/Black
JM5004		Half Corner W/ 2 Pockets	24 ft	Silver/Black
JM5003		Half Corner W/ 1 Pocket	24 ft	Silver/Black
JM5002		Half Corner W/O Pocket	24 ft	Silver/Black
JM5001		135° Corner Mullion	24 ft	Silver/Black
JM5022		Open Back Filler W/ Pocket	24 ft	Silver/Black
JM5021		Open Back Flat filler W/O Pocket	24 ft	Silver/Black
JM5020		Sill Cap	24 ft	Silver/Black
JM5019		Snap-in Door Stop	24 ft	Silver/Black
JM5018		Pocket Filler	24 ft	Silver/Black
JM5017		Sill Shear Block	15 ft	Silver/Black
JM5016		Head Shear Block	15 ft	Silver/Black



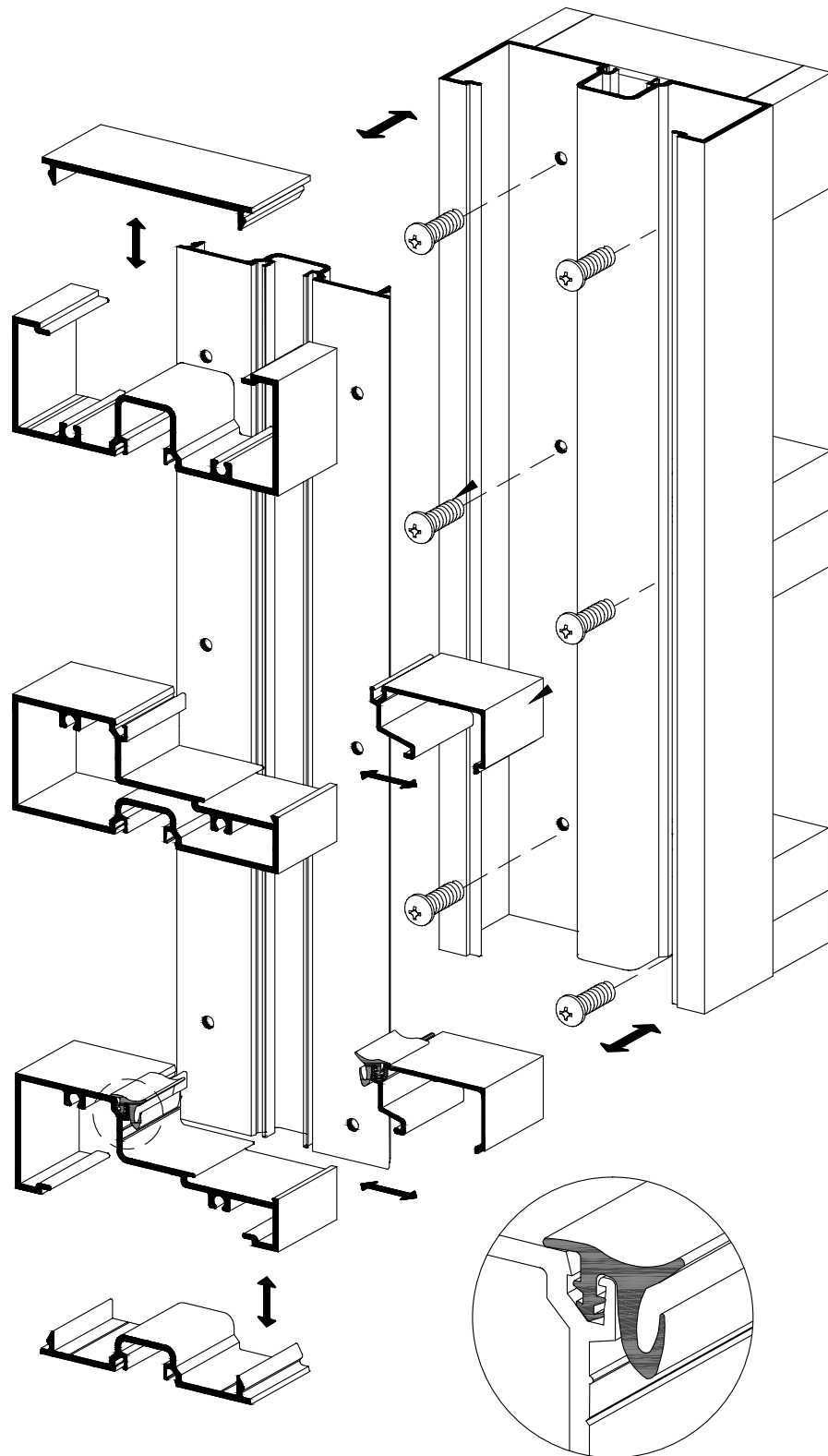



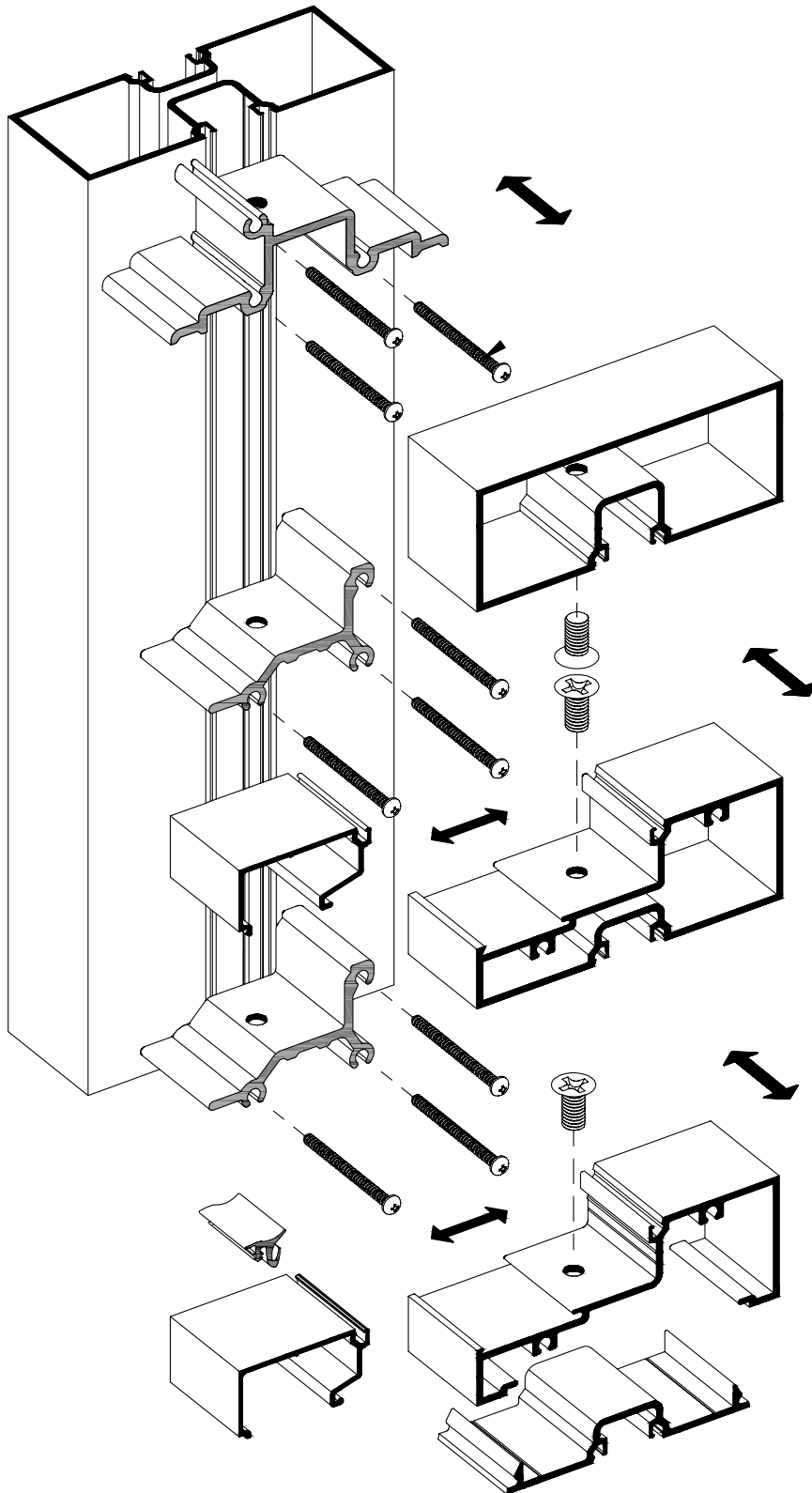



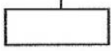
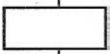
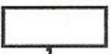

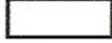
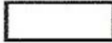

## Screw Spline Assembly



## Shear Block Assembly



## Fin & Flat Tube Angle & Channel

Part No.	Sectional View	Description	Length	Color
JM4001		1 3/4" x 4" Single Fin	24 ft	Silver/Black
JM4002		1 3/4" x 4" Double Fin	24 ft	Silver/Black
JM4003		1 3/4" x 4" Door Jamb W/ Strip	24 ft	Silver/Black
JM4004		1/2" Glass Molding	24 ft	Silver/Black
JM4005		1 3/4" x 1 3/4" Square Tube	24 ft	Silver/Black
JM4006		4" x 4" Square Tube	24 ft	Silver/Black
JM4007		1 3/4" x 4" Rectangle Tube	24 ft	Silver/Black
JM4008		1 3/4" x 4 1/2" Rectangle Tube	24 ft	Silver/Black
JM4009		2" x 4 1/2" Rectangle Tube	24 ft	Silver/Black
JM4010		4 1/2" Saddle	24 ft	Silver/Black
JM4011		1" x 1" (1/16" thick)	15 ft	Silver/Black
JM4012		1 1/2" x 1 1/2" (1/16" thick)	15 ft	Silver/Black
JM4013		1 3/4" x 1 3/4" (1/16" thick)	15 ft	Silver/Black
JM4014		5/8" x 3/4" (Inside:3/8")	12 ft	Silver/Black
JM4015		3/4" x 3/4" (Inside:1/2")	12 ft	Silver/Black
JM4016		1" x 1" (Inside:3/4")	12 ft	Silver/Black
JM4017		1 1/4" x 1 1/4" (Inside:1")	12 ft	Silver/Black
JM4018		J-Channel (Inside:1/4")	12 ft	Silver/Black



## Architectural Panel & Stock Door Glass







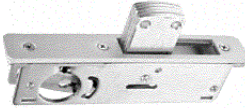

Aluminum Panel			
Part No.	Description	Size	Finish
PDSM48	Double Face Smooth	1/4"x4'x8'	AP, BP
PDSM410	Double Face Smooth	1/4"x4'x10'	AP, BP
P1DSM48	Insulated Double face Smooth	1"x4'x8'	AP, BP
P1DSM410	Insulated Double face Smooth	1"x4'x10'	AP, BP

Aluminum Sheet			
Part No.	Description	Size	Finish
AS48	.032 Aluminum Sheet	.032"x4'x8'	BP
AS410	.032 Aluminum Sheet	.032"x4'x10'	CL

NOTE: AP=ALUMINUM PAINT BP=EXTRA DARK BRONZE PAINT

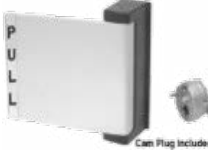
Stock Door Glass	
Part No.	Description
DGN3X7	31 1/4" x 76 5/8" (1/4" clear tempered glass for 3' x 7' narrow stile door)
DGM3X7	28 1/2" x 74 1/2" (1/4" clear tempered glass for 3' x 7' medium stile door)
DGM3X8	28 1/2" x 86 1/2" (1/4" clear tempered glass for 3' x 8' medium stile door)
DGN42X7	37 1/4" x 76 3/4" (1/4" clear tempered glass for 42" x 7' narrow stile door)
DGM42X7	34 3/8" x 74 3/8" (1/4" clear tempered glass for 42" x 7' medium stile door)
DGA3X7	35 3/4" x 77 1/8" (1/2" clear tempered glass for herculite door, 2 Long polished, W/ 2 holes)

## Door Hardware

Item	Part No.	Diagram	Description
Lock	DBLN		Dead bolt lock/face plate (1-1/8") For narrow door
	DBLM		Dead bolt lock/face plate (1-1/2") For medium door
	DHLN		Hook lock/face plate (1-1/8") For narrow door
	DHLM		Hook lock/face plate (1-1/2") For medium door
	DLLN		Latch lock/face plate (1-1/8") For narrow door
	DLLM		Latch lock/face plate (1-1/2") For medium door
Cylinder	CLD1		Cylinder(pair)
	TTC1		Thumb turn Cylinder
Paddle & Lever	PPH1		Aluminum universal push-pull paddle handle
	DLH1		Aluminum left hand lever handle
Door closer	DCS1		Door closers
	DC3T		Overhead concealed door closer 3000

## Door Hardware

Item	Part No.	Diagram	Description
Hinge	FCH7		7' Full mortise continuous hinge
	FCH8		8' Full mortise continuous hinge
	SCH7		7' Surface Continuous hinge
	SCH8		8' Surface Continuous hinge
	OPVH		Offset pivot hinge (L OR R)
	BTTH		Butt hinge
	HBUP		Hinge back-up plate
Exit device	MPB1		Mortised panic bar
Bolt & door holder	FEB2508		Flush extension bolt series 2508
	CCNB		Door Mounted 4 Heavy-Duty Stop and Holder
	HDSNH		Aluminum electric strike
Electric lock	AESK		Standard electromagnetic lock systems
	SELS		Standard electromagnetic lock systems
	TRSF12		12vdc power transformer
	TRSF18		Transformer 1800

## Door Hardware

Item	Part No.	Diagram	Description
Others	GSUC		Glass suction cup
	436E		1/4" or 1" Glazing rubber 360'
	ADSP		Aluminum door sweeps
	WTSTP		Storefront door pile weather strip
	SILICN		Silicone, clear, white/black/silver
	RSBS		Rubber setting blocks sbep6_448
	TSCP		320 threshold clip
	SFBK		Storefront brackets
	DJIG45		45 drill jig
	DJIG40		40 drill jig
	CSPR		Conical spring
	AFFP		Aluminum finish faceplate

## Handle

Part No.	Diagram		Color	
LSH24		24" ladder style pull	Chrome	Brushed nickel
LSH36		36" ladder style pull		
LSH48		48" ladder style pull		
LSH60		60" ladder style pull		
LSH72		72" ladder style pull		
OSMP		Offset mount mid-post for ladder pulls		
OSDP		12" Offset Door Pull	Silver	Black
PBPH		12" / 33" Solid Push Bar and Pull Handle Set		



## Screw

Part No.	Diagram	Description
JMS1		Hinge screw 12-24x1-2 U.C.(Al.Bz)
JMS2		#8-15x2 TSA PH H2 PN
JMS3		12X2 1-2 flat PH SMS 2N
JMS4		Self-tapping 14
JMS5		Screw spline self-drilling screw 12x1-4
JMS6		Self-drilling 10
JMS7		Self-tapping 8
JMS8		Shear block screw 10-24 x 1-2(Al.Bz)
JMS9		Molding self-tapping screw 6AX1(Al.Bz)
JMS0		Steel hex-head sleeve anchors

## Shower Door Enclosure

Part No.	Diagram	Description	Color	
PSH-107		Shower hinge, 90 degree, 2-1/2" wall to glass "H" plate	Chrome	Brushed nickel
PSH-103		Shower hinge, 180-degree glass to glass	Chrome	Brushed nickel
PGB-871S		Glass bracket, glass to wall	Chrome	Brushed nickel
PGB-872		Glass bracket, 90-degree glass	Chrome	Brushed nickel
PGB-882		Glass bracket, 90-degree glass	Chrome	Brushed nickel
PDH-27B		Stainless steel handles, 6"	Chrome	Brushed nickel
PSR-05		Door fixed panel wall-to-glass support bar	Chrome	Brushed nickel
PAL-01		Aluminum Deep U-Channel for 3/8" Thick Glass - 144"	Chrome	Brushed nickel
PTS-001		Polycarbonate H-Jamb 180 Degree for 3/8" Glass	Clear	
PTS-004		PVC Seal and Wipe for 3/8" Glass	Clear	
PTS-007		Bottom Wipe with Drip Rail for 3/8" Glass	Clear	
PCR-010		Vinyl Bulb Seal for 3/8" Glass	Clear	
SDG2876		28 x 76 shower swing door glass 3/8" clear tempered glass, all polished (2 hinge cut-out, 2 small holes for handle)	Clear	



## Glass

Type	Thickness	Annealed	Tempered
Clear glass	1/8"	√	N/A
	3/16"	√	√
	1/4"	√	√
	3/8"	√	√
	1/2"	√	√
	5/8"	√	√
	3/4"	√	√
Insulated glass unit	1/8" clear over 1/8" clear	√	N/A
	3/16" clear over 3/16" clear	√	√
	3/16" clear over 3/16" low E	√	√
	1/4" clear over 1/4" clear	√	√
	1/4" clear over 1/4" low E	√	√
	1/4" clear over 1/4" bronze	√	√
	1/4" clear over 1/4" gray	√	√
Laminated glass	1/4" clear	√	N/A
Clear starphire low iron glass	1/4"	√	√
	3/8"	√	√
	1/2"	√	√
	5/8"	√	√
	3/4"	√	√
Acid etch glass	1/4"	√	√
	3/8"	√	√
	1/2"	√	√
Starphire acid etch glass	1/4"	√	√
	3/8"	√	√
	1/2"	√	√
Low E glass	3/16"	√	√
	1/4"	√	√
Clear mirror	1/8"	√	N/A
	3/16"	√	N/A
	1/4"	√	N/A
Clear starphire mirror	1/4"	√	N/A
One way mirror	1/4"	√	√

## Storefront Prepare Service

Send us your storefront dimensions and details then we will take care of the rest.

The glass is fabricated to your specification.

All material is pre-cut.

Complete system ready to be installed!

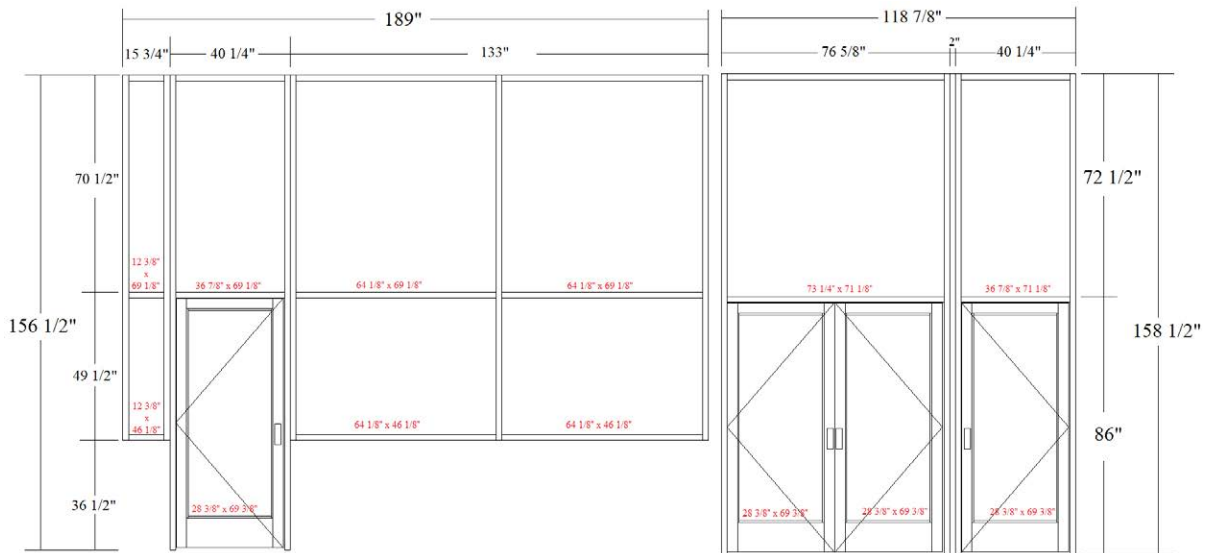



## **J&M Window Door Inc.**

COMMERCIAL DOORS & WINDOWS MANUFACTURER

Tel:215-728-1267 Fax:215-728-7307

SMS:267-888-8648

Email: [jmwindowdoors@gmail.com](mailto:jmwindowdoors@gmail.com)

4302 E Roosevelt Blvd, Philadelphia, PA 19124